



TELETRUK | 30/35D RANGE

Max capacity: 3500kg Max capacity at 2m forward reach: 1900-2600kg Max lift height: 5150mm



REACH FURTHER WITH JCB TELETRUK.

The NEW Stage V JCB Teletruk range provides unrivalled forward visibility, forward reach and large lift capacity, dramatically improving safety, while saving time, space and money. Offering three 2WD options (30-19D, 30-20D HL & 35-23D) and two 4WD options (30-23D & 35-26D), the diesel Teletruk range is built to reach further in logistics, construction, waste and agriculture.

REACH FOR PRODUCTIVITY.

The Teletruk is designed to make the most of your time and space, with its unique telescopic boom, small turning circle and single side loading.



REACH FOR GREATER SAFETY.

With superb visibility, precision control and unique design features, the Teletruk reaches new heights of safety, making all operators feel in total control.

REACH FOR GREATER VERSATILITY.

Four wheel drive delivers four tonnes of tractive effort, to support bucket work, travelling over rough ground and up to 21% gradients.



REACH FOR GREATER EFFICIENCY.

The JCB Teletruk's unique boom enables the operator to reach into the second or third row of materials improving efficiency and safety.

REACH FOR GREATER COMFORT.

The JCB CommandPlus cab ensures superior operator comfort, enabling you to gain maximum productivity from this uniquely versatile machine.

Willshee's
cycling

www.willshees.co.uk



STATIC DIMENSIONS

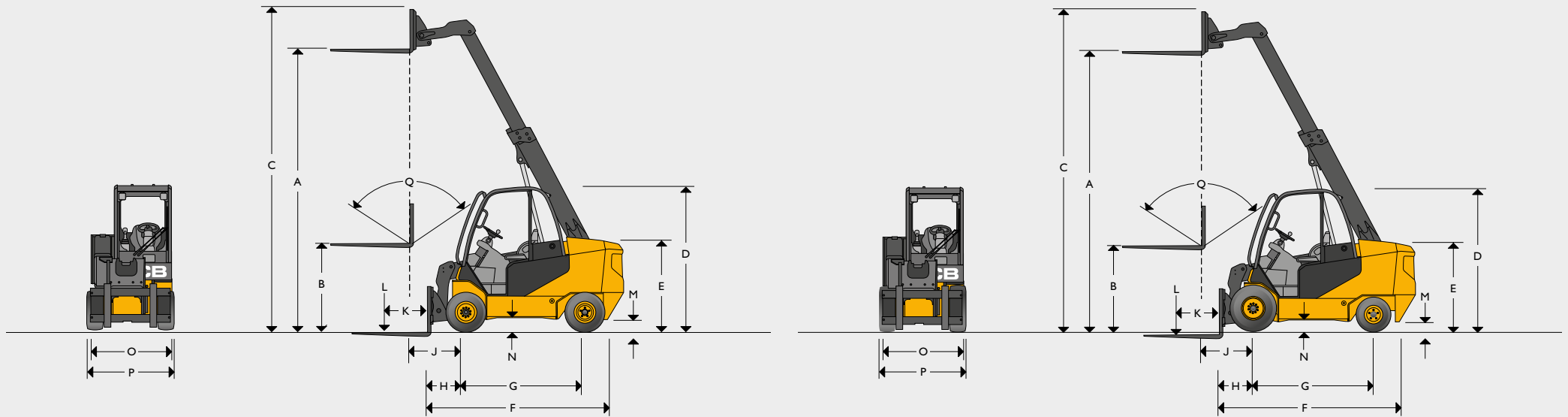

STATIC DIMENSIONS

Model	30-19D	30-20D HL	30-23D	35-23D	35-26D 4x4	
A	Lift height mm	4400	5150	4350	4400	4350
B	Free lift (standard) mm	1410	1410	1350	1410	1350
C	Height (boom extended) mm	4975	5700	5150	4975	5150
D	Height of overhead guard (standard/low) mm	2220/2140*	2220/2140*	2320/2240	2220/2140*	2320/2240
E	Height of operators seat mm	1140	1140	1250	1140	1250
F	Length to fork face mm	3106	3340	3106	3106	3106
G	Wheelbase mm	1950	2060	2060	1950	2060
H	Distance from c/l of front axle to fork face mm	529	770	529	529	529
J	Distance from c/l of front axle to fork face (full height) mm	729	540	729	729	729
K	Load centre mm	500	600	500	500	500
L	Lift capacities (with sideshift) kg	3000	3000	3000	3500	3500
M	Ground clearance (lowest point) mm	103	103	167	103	167
N	Ground clearance (wheelbase centre) mm	129	129	177	129	177
O	Fork carriage width mm	1200	1200	1200	1200	1200
P	Maximum width of machine mm	1300	1300	1410	1300	1410
Q	Carriage tilt total degrees	111	111	111	111	111

*Low option only available on construction and waste models.

GENERAL SPECIFICATION

Model	30-19D	30-20D HL	30-23D 4x4	35-23D	35-26D 4x4
Engine manufacturer	Kohler	Kohler	Kohler	Kohler	Kohler
Tier compliant	STV	STV	STV	STV	STV
Engine model	KDI2504	KDI2504	KDI2504	KDI2504	KDI2504
Engine output (gross power)	46kW @ 2600RPM	46kW @ 2600RPM	46kW @ 2600RPM	46kW @ 2600RPM	46kW @ 2600RPM
Cubic capacity	cm ³ 2504	2504	2504	2504	2504
Rated RPM	2600	2600	2600	2600	2600
Number of cylinders	4	4	4	4	4
Working pressure attachments	bar 260	260	260	260	260
Oil flow for attachments (standard / high)	lpm 28/70	28/70	28/70	28/70	28/70
Maximum reach ground level (500mm load centre)	mm 2230	2230	3300	2230	2230
Maximum reach boom horizontal (500mm load centre)	mm 2390	2390	3320	2390	2390
Turning radius mm	mm 2885	2885	3500	2885	3500
Aisle width 90 stacking 800x1200/1000x1200	mm 4480/4680	4480/4680	5060/5260	4480/4680	5060/5260
Weight unladen	kg 5200	5750	5600	5600	5980
Travel speed (standard)	kph 20	20	20	20	20
Gradeability (unladen)	kph 21	21	23	21	23
Transmission	TCR/Hydrostatic	TCR/Hydrostatic	TCR/Hydrostatic	TCR/Hydrostatic	TCR/Hydrostatic
Park break type	Hand	Hand	Hand	Hand	Hand
Shovel rated capacity	m ³ 0.6	0.6	0.6	0.6	0.6
Shovel struck capacity	m ³ 0.5	0.5	0.5	0.5	0.5
Shovel dump height (30)	mm 2680	2680	2680	2680	2680
Shovel rollback angle at ground	degrees 37	37	33	37	33
Shovel width	mm 1385	1385	1385	1385	1385
Tyres PPS (Semi solid) P (Pneumatic)	PPS/P	PPS/P	PPS/P/FOAM	PPS/P	PPS/P/FOAM
Tyre size front (standard)	27 x 10 x 12	27 x 10 x 12	27 x 10 x 12	27 x 10 x 12	27 x 10 x 12
Tyre size rear (standard)	23 x 9 x 10	23 x 9 x 10	27 x 10 x 12	23 x 9 x 10	27 x 10 x 12
Diesel tank capacity litres	litres 50	50	49	50	49

LIFT CAPACITIES

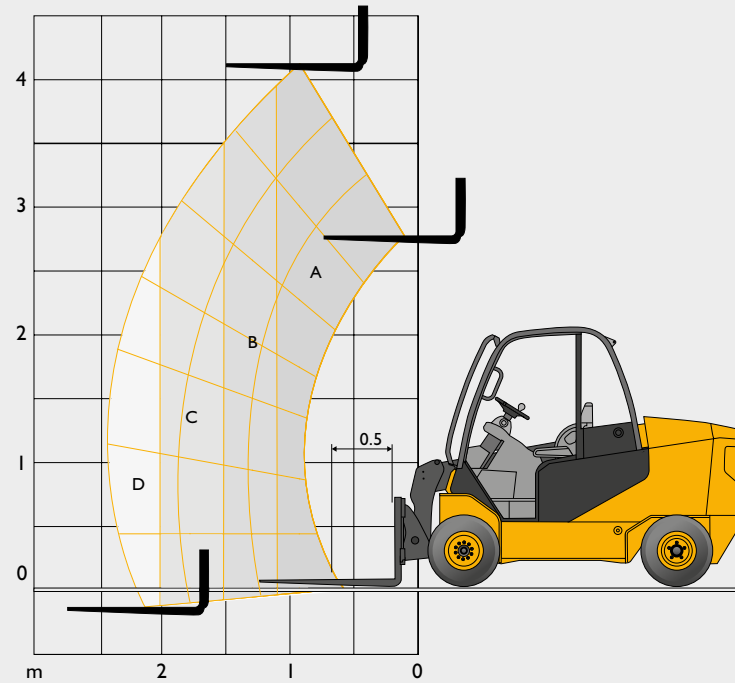

Capacity bands	30-19D
A	3000kg
B	2500kg
C	1950kg
D	1500kg
@ 2 metres	1950kg

Capacity bands	30-20D HL
A	3000kg
B	2500kg
C	2000kg
D	1750kg
@ 2 metres	2000kg

Capacity bands	30-23D 4x4
A	3000kg
B	2600kg
C	2300kg
D	1650kg
@ 2 metres	2300kg

Capacity bands	35-23D
A	3500kg
B	3000kg
C	2300kg
D	1750kg
@ 2 metres	2300kg

Capacity bands	35-26D 4x4
A	3500kg
B	3000kg
C	2600kg
D	2050kg
@ 2 metres	2600kg



WASTEMASTER

JCB

JCB
TELETRUK

30-23D

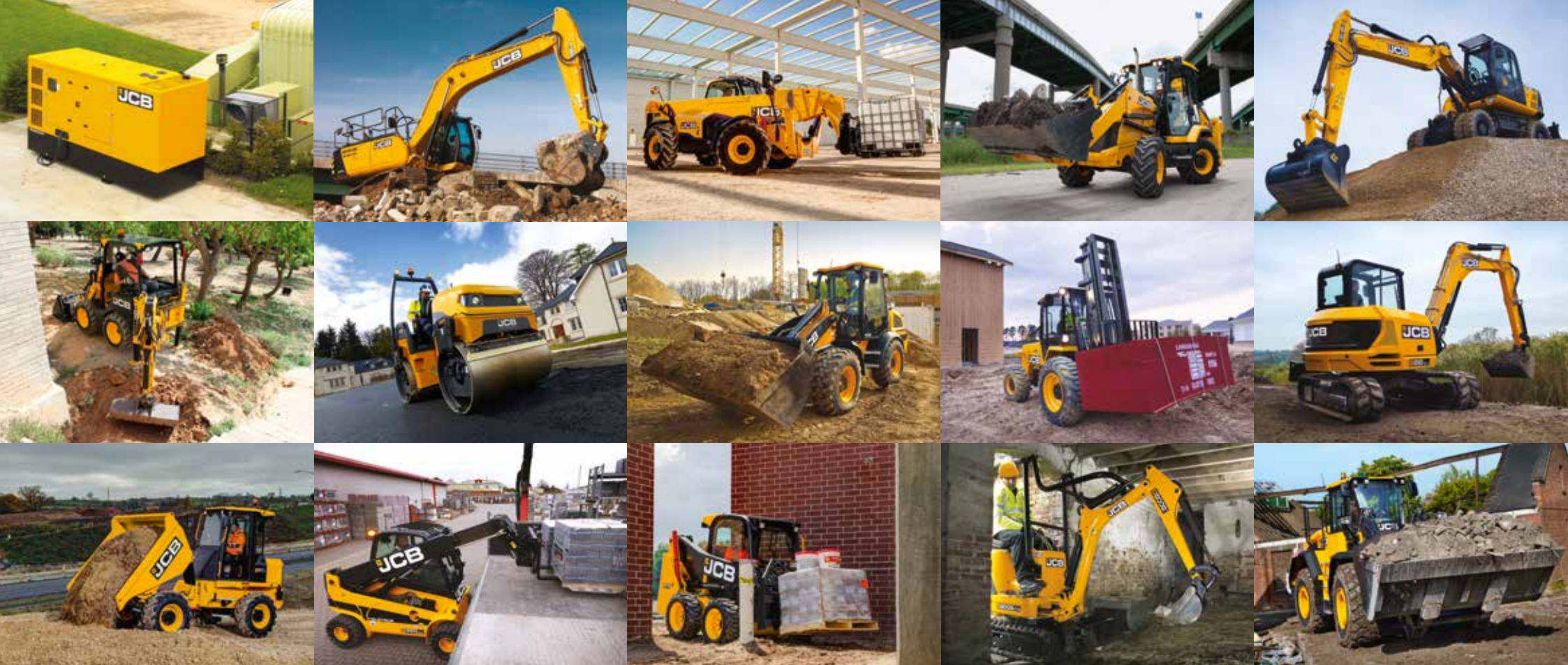

ONE COMPANY, OVER 300 MACHINES.

Your nearest JCB dealer

TELETRUK 30/35D RANGE

Max capacity: 3500kg Max capacity at 2m forward reach: 1900-2600kg Max lift height: 5150mm

JCB Sales Limited, Rokester, Staffordshire, United Kingdom ST14 5JP.

Tel: +44 (0)1889 590312 Email: salesinfo@jcb.com

Download the very latest information on this product range at: www.jcb.com

©2022 JCB Sales. All rights reserved. No part of this publication may be reproduced, stored in a retrieval system, or transmitted in any form or by any other means, electronic, mechanical, photocopying or otherwise, without prior permission from JCB Sales. All references in this publication to operating weights, sizes, capacities and other performance measurements are provided for guidance only and may vary dependant upon the exact specification of machine. They should not therefore be relied upon in relation to suitability for a particular application. Guidance and advice should always be sought from your JCB Dealer. JCB reserves the right to change specifications without notice. Illustrations and specifications shown may include optional equipment and accessories. All images are correct at time of print. The JCB logo is a registered trademark of J C Bamford Excavators Ltd.

